

Always there to help you

Register your product and get support at
www.philips.com/welcome



MCM1120



User manual

PHILIPS

Contents

1	Important	2		
	Safety	2		

2	Your micro system	4		
	Introduction	4		
	What's in the box	4		
	Overview of the main unit	5		
	Overview of the remote control	6		

3	Get started	7		
	Connect speakers	7		
	Connect power	8		
	Prepare the remote control	8		
	Turn on	8		
	Set clock	9		

4	Play	9		
	Basic play operations	9		
	Play discs	9		
	Play from USB	10		
	Adjust sound	10		
	Program audio tracks	10		
	Listen to tape	11		

5	Listen to radio	12		
	Tune to FM radio stations	12		
	Program radio stations automatically	12		
	Program radio stations manually	13		
	Show RDS information	13		

6	Other features	14		
	Set alarm timer	14		
	Set sleep timer	14		
	Listen to external audio device	14		
	Listen through headphone	14		

7	Product information	15		
	Specifications	15		
	USB playability information	15		
	Supported MP3 disc formats	16		
	Maintenance	16		

8	Troubleshooting	17		
----------	------------------------	-----------	--	--

9	Notice	18		
----------	---------------	-----------	--	--

1 Important

Safety



This 'bolt of lightning' indicates uninsulated material within the device may cause an electrical shock. For the safety of everyone in your household, please do not remove the covering.

The 'exclamation mark' calls attention to features for which you should read the enclosed literature closely to prevent operating and maintenance problems.

WARNING: To reduce the risk of fire or electric shock, the device should not be exposed to rain or moisture and objects filled with liquids, such as vases, should not be placed on the device.

CAUTION: To prevent electric shock, fully insert the plug. (For regions with polarized plugs: To prevent electric shock, match wide blade to wide slot.)

Important Safety Instructions

- Follow all instructions.
- Heed all warnings.
- Do not use this device near water.
- Clean only with dry cloth.
- Do not block any ventilation openings. Install in accordance with the manufacturer's instructions.
- Do not install near any heat sources such as radiators, heat registers, stoves, or other devices (including amplifiers) that produce heat.
- Protect the power cord from being walked on or pinched, particularly at plugs,

convenience receptacles, and the point where they exit from the device.

- Only use attachments/accessories specified by the manufacturer:
- Use only with the cart, stand, tripod, bracket, or table specified by the manufacturer or sold with the device. When a cart is used, use caution when moving the cart/device combination to avoid injury from tip-over.



- Unplug this device during lightning storms or when unused for long periods of time.
- Refer all servicing to qualified service personnel. Servicing is required when the device has been damaged in any way, such as power-supply cord or plug is damaged, liquid has been spilled or objects have fallen into the device, the device has been exposed to rain or moisture, does not operate normally, or has been dropped.
- Battery usage **CAUTION** – To prevent battery leakage which may result in bodily injury, property damage, or damage to the unit:
 - Install all batteries correctly, + and - as marked on the unit.
 - Do not mix batteries (old and new or carbon and alkaline, etc.).
 - Batteries (packed or installed) shall not be exposed to excessive heat such as sunshine, fire or the like.
 - Remove batteries when the unit is not used for a long time.
- The device shall not be exposed to dripping or splashing.
- Do not place any sources of danger on the device (e.g. liquid filled objects, lighted candles).

- Where the MAINS plug or an appliance coupler is used as the disconnect device, the disconnect device shall remain readily operable.



Warning

- Never remove the casing of this apparatus.
- Never lubricate any part of this apparatus.
- Never place this apparatus on other electrical equipment.
- Never look into the laser beam inside this apparatus.
- Make sure that you always have easy access to the power cord, plug, or adaptor to disconnect the apparatus from the power.

Hearing safety



Listen at a moderate volume.

- Using headphones at a high volume can impair your hearing. This product can produce sounds in decibel ranges that may cause hearing loss for a normal person, even for exposure less than a minute. The higher decibel ranges are offered for those that may have already experienced some hearing loss.
- Sound can be deceiving. Over time your hearing 'comfort level' adapts to higher volumes of sound. So after prolonged listening, what sounds 'normal' can actually be loud and harmful to your hearing. To guard against this, set your volume to a safe level before your hearing adapts and leave it there.

To establish a safe volume level:

- Set your volume control at a low setting.
- Slowly increase the sound until you can hear it comfortably and clearly, without distortion.

Listen for reasonable periods of time:

- Prolonged exposure to sound, even at normally 'safe' levels, can also cause hearing loss.
- Be sure to use your equipment reasonably and take appropriate breaks.

Be sure to observe the following guidelines when using your headphones.

- Listen at reasonable volumes for reasonable periods of time.
- Be careful not to adjust the volume as your hearing adapts.
- Do not turn up the volume so high that you can't hear what's around you.
- You should use caution or temporarily discontinue use in potentially hazardous situations. Do not use headphones while operating a motorized vehicle, cycling, skateboarding, etc.; it may create a traffic hazard and is illegal in many areas.

2 Your micro system

Congratulations on your purchase, and welcome to Philips! To fully benefit from the support that Philips offers, register your product at www.philips.com/welcome.

Introduction

With this unit, you can:

- enjoy audio from discs, USB storage devices, tapes, and other external devices;
- listen to radio stations.

You can enrich sound output with the following sound effects:

- Digital Sound Control (DSC)
- Dynamic Bass Boost (DBB)

The unit supports the following media formats:



What's in the box

Check and identify the contents of your package:

- Main unit
- 2 x speakers
- Remote control
- MP3 link cable
- Quick start guide
- User manual

Overview of the main unit

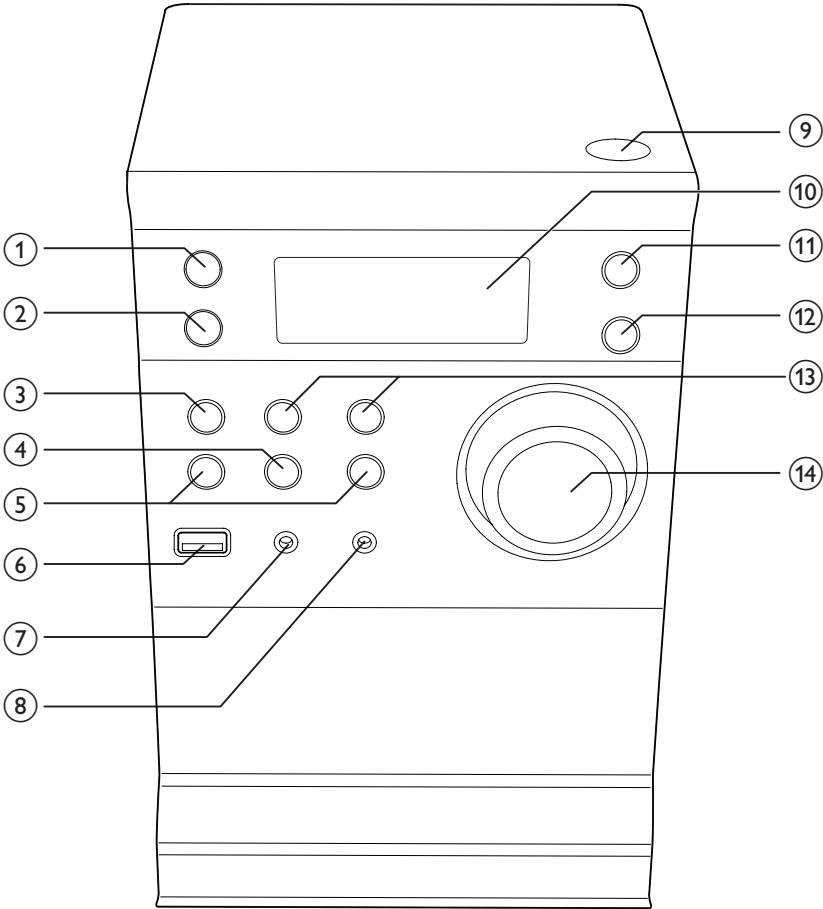

① 

- Turn on the main unit
- Switch to standby mode

② **SOURCE**

- Select a source.

③ **■ STOP**

- Stop play or erase a program.

④ **▶|| PLAY/PAUSE**

- Start or pause play.

⑤ **◀◀/▶▶ PREVIOUS/NEXT**



- Skip to the previous/next track.
- Fast reverse or fast forward within a track or disc.
- Tune to a radio station.
- Adjust time.

⑥ 

- Connect to USB storage device.

⑦ **MP3-LINK**

- Connect to an external audio device.

- ⑧ 
 - Connect to a headphone.
- ⑨ 
 - Open/close the disc compartment.
- ⑩ **Display panel**
 - Show current status.
- ⑪ **MODE**
 - Select repeat play mode in CD, or USB source.
 - Select shuffle play mode in CD, or USB source.
- ⑫ **CLOCK**
 - Set clock.
- ⑬ **ALBUM/PRESET +/-**
 - Select a preset radio station.
 - Skip to the previous/next album.
- ⑭ **VOLUME (Volume knob)**
 - Adjust volume.

Overview of the remote control

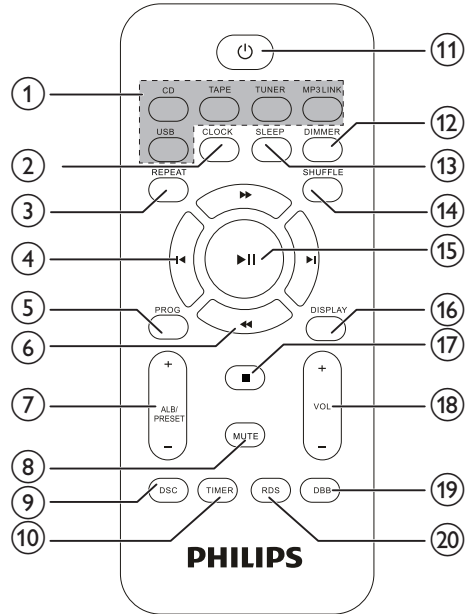

- ① **Source selection keys (CD, USB, TUNER, TAPE, MP3 LINK)**
 - Select a source.
- ② **CLOCK**
 - Set clock.
- ③ **REPEAT**
 - Select a repeat play mode: repeat one track or all tracks.
- ④ **◀ / ▶**
 - Skip to the previous/next track.
 - Tune to a radio station.
 - Adjust time.
- ⑤ **PROG**
 - Program tracks.
 - Program radio stations.
- ⑥ **◀◀ / ▶▶**
 - Fast reverse or fast forward within a track or disc.

- ⑦ **ALB/PRESET +/-**
 - Skip to the previous/next album.
 - Select a preset radio station.
- ⑧ **MUTE**
 - Mute volume.
- ⑨ **DSC**
 - Select a preset sound setting: POP, JAZZ, ROCK, or CLASSIC.
- ⑩ **TIMER**
 - Set the alarm timer.
- ⑪ **⏻**
 - Turn on the main unit.
 - Switch to standby mode.
- ⑫ **DIMMER**
 - Access illuminate dimmer settings.
- ⑬ **SLEEP**
 - Set the sleep timer.
- ⑭ **SHUFFLE**
 - Play tracks randomly.
- ⑮ **▶||**
 - Start or pause play.
- ⑯ **DISPLAY**
 - Show playback information.
- ⑰ **■**
 - Stop play or erase a program.
- ⑱ **VOL +/-**
 - Adjust volume.
- ⑲ **DBB**
 - Turns on or off dynamic bass enhancement.
- ⑳ **RDS**
 - For selected FM radio stations: display RDS information.

3 Get started



Caution

- Use of controls or adjustments or performance of procedures other than herein may result in hazardous radiation exposure or other unsafe operation.

Always follow the instructions in this chapter in sequence.

If you contact Philips, you will be asked for the model and serial number of this apparatus. The model number and serial number are on the back of the apparatus. Write the numbers here:

Model No. _____

Serial No. _____

Connect speakers



Note

- Make sure that the colors of the speaker wires and terminals are matched.

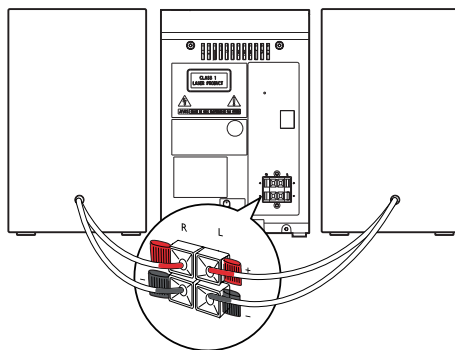

- 1 Hold down the socket flap.
- 2 Insert the stripped part of the wire completely.
 - Insert the right speaker wires to "RIGHT", left speaker wires to "LEFT".
 - Insert the red wires to "+", black wires to "-".

3 Release the socket flap.

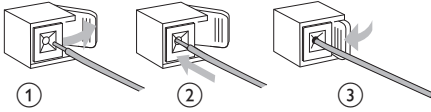

Connect power

! Caution

- Risk of product damage! Ensure that the power supply voltage corresponds to the voltage printed on the back or the underside of the unit.
- Risk of electric shock! When you unplug the AC power cord, always pull the plug from the socket. Never pull the cord.
- Before you connect the AC power cord, make sure that you have completed all other connections.

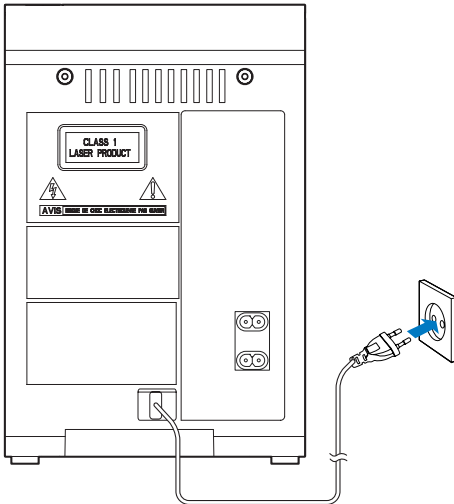

Prepare the remote control

! Caution

- Risk of explosion! Keep batteries away from heat, sunshine or fire. Never discard batteries in fire.
- Risk of decreased battery life! Never mix different brands or types of batteries.
- Risk of product damage! When the remote control is not used for long periods, remove the batteries.
- Danger of explosion if battery is incorrectly replaced. Replace only with the same or equivalent type.

To insert the remote control battery:

- 1 Open the battery compartment.
- 2 Insert 2 AAA batteries with correct polarity (+/-) as indicated.
- 3 Close the battery compartment.

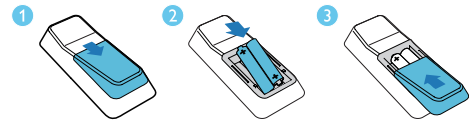

Turn on

Press **⏻** to turn on.

- ↳ The unit switches to the last selected source.

✦ Tip

- In standby mode, you can also press **CD, TUNER, MP3 LINK** to switch on the unit.

Switch to standby mode

Press **⏻** again to switch the unit to standby mode.

- ↳ The clock (if set) appears on the display panel.

Note

- When the unit remains idle for 15 minutes, it switches from standby mode automatically.

Set clock

- 1 In standby mode, press and hold **CLOCK** on the remote control for more than two seconds.
↳ [24H] or [12H] hour format is displayed.
- 2 Press **◀/▶** to select [24H] or [12H] hour format.
- 3 press **CLOCK** to confirm.
↳ The hour digits are displayed and begin to blink.
- 4 Repeat steps 2-3 to set hour and minute.

Note

- If no button is pressed in 90 seconds, the system exits clock setting mode automatically.

Tip

- You can view clock information in power-on mode by pressing **CLOCK**.

4 Play

Basic play operations

You can control play through following operations.

Key	Function
◀◀/▶▶	Press and hold to fast-forward/fast-reverse the track during playback, then release to resume play.
▶	To pause/resume play during playback.
DISPLAY	Select different play information.
REPEAT	To select a repeat play mode: [REP] (repeat): play current track repeatedly. [REP ALL] (repeat all): play all tracks repeatedly. Press again to return to normal play.
SHUFFLE	To play tracks randomly. Press again to return to normal play.

Play discs

- 1 Press **CD** on the remote control to select the disc source.
- 2 Press **▲** on the top of the main unit.
↳ The disc door opens.
- 3 Place a disc face up onto the tray and press **▲** again.
↳ Play starts automatically.

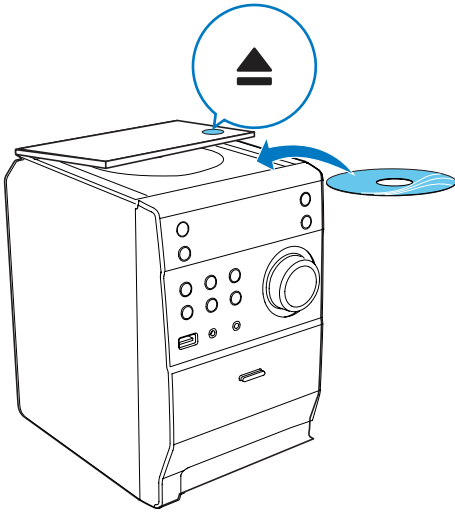

Tip

- If your main unit does not start to play, press **◀◀ / ▶▶** to select a track and then press **▶||**.

Play from USB

Note

- Make sure that the USB storage device contains playable audio contents for supported formats.

- 1 Insert a USB storage device into the  socket on the main unit.
- 2 Press **USB** to select the USB source.
↳ The total number of tracks displays.
- 3 Press **ALB/PRESET+/-** to select a folder.
- 4 Press **◀ / ▶** to select a file.
- 5 Press **▶||** to start play.

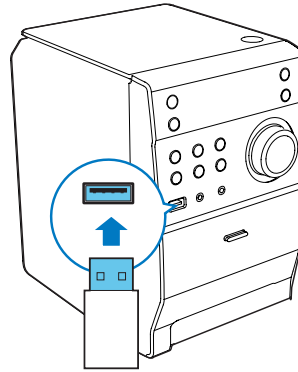

Adjust sound

During play, you can adjust volume through following operations.

Key	Function
VOL +/-	To increase/decrease the volume.
MUTE	To mute/restore sound.
DBB	To turn on or off dynamic bass enhancement. If DBB is activated, [DBB] is displayed.
DSC	To select your desired sound effect: [POP] (pop) [JAZZ] (jazz) [CLASSIC] (classic) [ROCK] (rock)

Program audio tracks

You can program a maximum of 20 tracks.

- 1 In CD or USB mode, press **■** to stop play.
- 2 Press **PROG.**
↳ **[PROG]** (program) is displayed.
- 3 For MP3/WMA tracks, press **ALBUM/PRESET+/-** repeatedly to select an album.

- 4 Press **◀/▶** to select a track number, then press **PROG** to confirm.
- 5 Repeat steps 3 and 4 to program more tracks.
- 6 Press **▶||** to play the programmed tracks.
 - ↳ During play, **[PROG]** (program) is displayed.
 - ↳ To erase the program, press **■** when play is stopped.

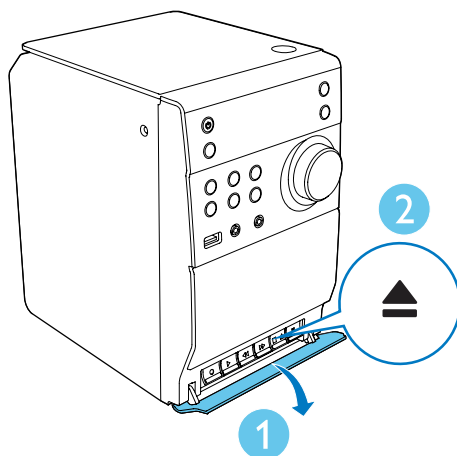

Listen to tape

Note

- When you play or record a tape, the sound source cannot be changed.
- To record, use only "Normal" (IEC type I) tapes on which the write-protect notches (tabs) are not broken.

Play a tape

- 1 Press **TAPE** to select the tape source, and pull to open the tape button cover on the front.
- 2 Press **■▲** to open the tape door.
- 3 Load a tape with the open side downward and the full spool to the left, and close the tape door.
- 4 Close the tape door.
- 5 Press **▶** to start play.
 - To pause or resume play, press **||**.
 - To stop the play, press **■**.
 - To fast rewind or wind the tape, press **◀/▶▶**.

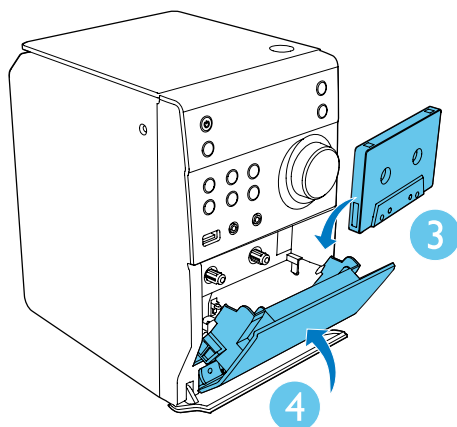

Record from CD to tape

- 1 Press **CD** to select the **CD** source.
- 2 Load a disc.
 - To record from the beginning of the disc, stop disc play from the beginning.
 - To record a section of the disc, stop disc play from the beginning of the section.
- 3 Pull to open the tape button cover on the front.
- 4 Press **■▲** to open the tape door:

- 5 Load a tape with the open side downward and the full spool to the left, and close the tape door.
- 6 Press ● to start recording.
 - ↳ Disc play starts automatically from the beginning of the disc or the selected section.
 - To pause or resume recording, press ■■.
 - To stop recording, press ■▲.

Record from radio to tape

- 1 Tune to a radio station.
- 2 Pull to open the tape button cover.
- 3 Press ■▲ to open the tape door.
- 4 Load a tape with the open side downward and the full spool to the left, and close the tape door.
- 5 Press ● to start recording.
 - To pause or resume recording, press ■■.
 - To stop recording, press ■▲.

5 Listen to radio

Tune to FM radio stations

Note

- Make sure that you have connected and fully extended the supplied FM antenna.

- 1 Press **TUNER**.
- 2 Press ◀◀/▶▶ on the remote control or press and hold ◀◀/▶▶ on the front panel for two seconds to tune to a radio station.
- 3 When the frequency starts to change, release the button.
 - ↳ The FM tuner tunes to a station with strong reception automatically.
- 4 Repeat steps 2-3 to tune to more stations.

To tune to a weak station:

Press ◀/▶ repeatedly until you find optimal reception.

Program radio stations automatically

Note

- You can program a maximum of 20 preset radio stations.

In FM tuner mode, press **PROG** for 3 seconds to activate automatic programming.

↳ **[AUTO]** (auto) is displayed.

↳ The unit stores all the FM radio stations automatically and then broadcasts the first preset radio station.

Program radio stations manually

Note

- You can program a maximum of 20 preset radio stations.

- 1 Tune to a radio station.
- 2 Press **PROG** to activate programming mode.
- 3 Press **ALB/PRESET+/-** to select a number from 1 to 20 for this radio station, then press **PROG** to confirm.
 - ↳ The preset number and the frequency of the preset station are displayed.
- 4 Repeat steps 2-3 to program other stations.

Note

- To overwrite a programmed station, store another station in its place.

Synchronize clock with RDS

You can synchronize time shown on the unit with that on the RDS station.

- 1 Tune to a RDS radio station that transmits time signals.
- 2 Press **RDS** for over 2 seconds.
 - ↳ **[CT SYNC]** is displayed and the unit reads RDS time automatically.
 - ↳ If no time signal is received, **[NO CT]** is displayed.

Note

- The accuracy of the transmitted time depends on the RDS station that transmits the time signal.

Show RDS information

RDS (Radio Data System) is a service that allows FM stations to show additional information. If you tune to an RDS station, an RDS icon and the station name are displayed.

- 1 Tune to an RDS station.
- 2 Press **RDS** repeatedly to scroll through the following information (if available):
 - ↳ Station name
 - ↳ Program type such as **[NEWS]** (news), **[SPORT]** (sport), **[POP M]** (pop music)...
 - ↳ Radio text
 - ↳ Frequency

6 Other features

Set alarm timer

This unit can be used as an alarm clock. You can select DISC, USB, or FM TUNER as alarm source.

Note

- Make sure that you have set the time correctly.

- 1 In standby mode, press and hold **TIMER** until **[TIMER SET]**(timer set) scrolls on the display.
↳ **[SELECT SOURCE]** (select source) scrolls on the screen.
- 2 Press **SOURCE** repeatedly to select a source: DISC, USB, or FM TUNER.
- 3 Press **TIMER** to confirm.
↳ The hour digits are displayed and begin to blink.
- 4 Press **◀ / ▶** repeatedly to set hour, then press **TIMER** again to confirm.
↳ The minute digits are displayed and begin to blink.
- 5 Press **◀ / ▶** to set minute, then press **TIMER** to confirm.
↳ **⌚** is displayed.

Activate/deactivate alarm timer

In standby mode, press **TIMER** repeatedly to activate or deactivate timer.

- ↳ If timer is activated, **⌚** is displayed.

Note

- Alarm timer is not available in MP3 LINK mode.
- If DISC/USB source is selected, yet no disc is placed or no USB is connected, the system switches to the tuner source automatically.

Set sleep timer

When the unit is turned on, press **SLEEP** repeatedly to select a time period (in minutes).

- ↳ When sleep timer is activated, **zZ** is displayed.
- ↳ To deactivate sleep timer, press **SLEEP** again until **zZ** disappears.

Listen to external audio device

You can listen to an external audio device such as MP3 player through this unit.

- 1 Connect the audio device.
 - For audio device with headphone sockets:
Connect MP3 Link cable to the **MP3-LINK** socket and to the headphone socket on the audio device.
- 2 Select **MP3-LINK** source.
- 3 Play the device.

Listen through headphone

Plug a headphone into the **🎧** socket on the unit.

7 Product information

Note

- Product information is subject to change without prior notice.

Specifications

Amplifier

Rated Output Power	2 x 5 W RMS
Frequency Response	60 Hz - 16 kHz, ± 3 dB
Signal to Noise Ratio	>65 dB
Aux Input	0.5V RMS 20 kohm

Speakers

Speaker Impedance	4 ohm
Speaker Driver	3.5"
Sensitivity	>82 dB/m/W

Disc

Laser Type	Semiconductor
Disc Diameter	12 cm/8 cm
Support Disc	CD-DA, CD-R, CD-RW, MP3-CD
Audio DAC	24 Bits / 44.1 kHz
Total Harmonic Distortion	<1%
Frequency Response	60 Hz -16 kHz (44.1 kHz)
S/N Ratio	>65 dBA

Tuner

Tuning Range	FM: 87.5-108 MHz
--------------	------------------

Tuning Grid	50 KHz
Sensitivity	< 22 dBf
- Mono, 26 dB S/N Ratio	< 22 dBf
Search selectivity	< 36 dBu
Total harmonic distortion	< 3 %
Signal to noise ratio	> 45 dB

General information

AC power	100-240V~, 50/60 Hz
Operation Power Consumption	10 W
Standby Power Consumption	< 1 W
Dimensions	
- Main Unit (W x H x D)	150 x 227 x 208.5 mm
- Speaker Box (W x H x D)	140 x 227 x 158.6 mm
Weight	
- Main Unit	1.265 kg
- Speaker Box	2 x 1.063 kg

USB playability information

Compatible USB storage devices:

- USB flash memory (USB 2.0 or USB1.1)
- USB flash players (USB 2.0 or USB1.1)
- memory cards (requires an additional card reader to work with this apparatus)

Supported formats:

- USB or memory file format FAT12, FAT16, FAT32 (sector size: 512 bytes)
- MP3 bitrate (data rate): 32-320 Kbps and variable bitrate
- Directory nesting up to a maximum of 8 levels
- Number of albums/ folders: maximum 99
- Number of tracks/titles: maximum 999
- ID3 tag v2.0 or later

- File name in Unicode UTF8 (maximum length: 32 bytes)

Unsupported formats:

- Empty albums: an empty album is an album that does not contain MP3/WMA files.
- Unsupported file formats are skipped. For example, Word documents (.doc) or MP3 files with extension .dlf are ignored and not played.
- AAC, WAV, PCM audio files
- DRM protected WMA files (*.wav, *.m4a, *.m4p, *.mp4, *.aac)
- WMA files

Supported MP3 disc formats

- ISO9660, Joliet
- Maximum title number: 512 (depending on file name length)
- Maximum album number: 255
- Supported sampling frequencies: 32 kHz, 44.1kHz, 48 kHz
- Supported Bit-rates: 32~256 (kbps), variable bit rates

Maintenance

Clean the cabinet

- Use a soft cloth slightly moistened with a mild detergent solution. Do not use a solution containing alcohol, spirits, ammonia or abrasives.

Clean discs

- When a disc becomes dirty, clean it with a cleaning cloth. Wipe the disc from the centre out.

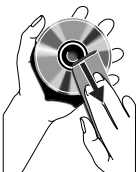

- Do not use solvents such as benzene, thinner; commercially available cleaners, or antistatic spray intended for analogue records.

Clean the disc lens

- After prolonged use, dirt or dust may accumulate at the disc lens. To ensure good play quality, clean the disc lens with Philips CD lens cleaner or any commercially available cleaner. Follow the instructions supplied with cleaner.

Clean the heads and the tape paths

- To ensure good recording and play quality, clean the heads **A**, the capstan(s) **B**, and pressure roller(s) **C** after every 50 hours of tape operation.
- Use a cotton swab slightly moistened with cleaning fluid or alcohol.

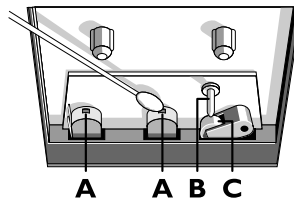

- You can also clean the heads by playing a cleaning tape once.

Demagnetise the heads

- Use a demagnetising tape available at your dealer.

8 Troubleshooting



Warning

- Never remove the casing of this device.

To keep the warranty valid, never try to repair the system yourself.

If you encounter problems when using this device, check the following points before requesting service. If the problem remains unsolved, go to the Philips Web page (www.philips.com/support). When you contact Philips, make sure that the device is nearby and the model number and serial number are available.

No power

- Ensure that the AC power plug of the unit is connected properly.
- Ensure that there is power at the AC outlet.
- As a power-saving feature, the unit switches off automatically 15 minutes after track play reaches the end and no control is operated.

No sound or poor sound

- Adjust the volume.
- Disconnect the headphones.
- Check that the speakers are connected correctly.
- Check if the stripped speaker wires are clamped.

Left and right sound outputs reversed

- Check the speaker connections and location.

No response from the apparatus

- Disconnect and reconnect the AC power plug, then turn on the system again.
- As a power-saving feature, the system switches off automatically 15 minutes after track play reaches the end and no control is operated.

Remote control does not work

- Before you press any function button, first select the correct source with the remote control instead of the main unit.
- Reduce the distance between the remote control and the unit.
- Insert the battery with its polarities (+/- signs) aligned as indicated.
- Replace the battery.
- Aim the remote control directly at the sensor on the front of the unit.

No disc detected

- Insert a disc.
- Check if the disc is inserted upside down.
- Wait until the moisture condensation at the lens has cleared.
- Replace or clean the disc.
- Use a finalized CD or correct format disc.

Cannot display some files in USB device

- The number of folders or files in the USB device has exceeded a certain limit. This phenomenon is not a malfunction.
- The formats of these files are not supported.

USB device not supported

- The USB device is incompatible with the unit. Try another one.

Poor radio reception

- Increase the distance between the unit and your TV or VCR.
- Fully extend the FM antenna.

Timer does not work

- Set the clock correctly.
- Switch on the timer.

Clock/timer setting erased

- Power has been interrupted or the power cord has been disconnected.
- Reset the clock/timer.

9 Notice

Any changes or modifications made to this device that are not expressly approved by Philips Consumer Lifestyle may void the user's authority to operate the equipment.

Your product is designed and manufactured with high quality materials and components, which can be recycled and reused.

Never dispose of your product with other household waste. Please inform yourself about the local rules on the separate collection of electrical and electronic products and batteries. The correct disposal of these products helps prevent potentially negative consequences on the environment and human health.

Your product contains batteries, which cannot be disposed of with normal household waste. Please inform yourself about the local rules on separate collection of batteries. The correct disposal of batteries helps prevent potentially negative consequences on the environment and human health.

Please visit www.recycle.philips.com for additional information on a recycling center in your area.

Environmental information

All unnecessary packaging has been omitted. We have tried to make the packaging easy to separate into three materials: cardboard (box), polystyrene foam (buffer) and polyethylene (bags, protective foam sheet.)

Your system consists of materials which can be recycled and reused if disassembled by a specialized company. Please observe the local regulations regarding the disposal of packaging materials, exhausted batteries and old equipment.



Be responsible
Respect copyrights

The making of unauthorized copies of copy-protected material, including computer programs, files, broadcasts and sound recordings, may be an infringement of copyrights and constitute a criminal offence. This equipment should not be used for such purposes.

This apparatus includes this label:



Note

- The type plate is located on the back of the unit.



Specifications are subject to change without notice
© 2013 Koninklijke Philips Electronics N.V.
All rights reserved.

MCM1120_61_UM_V2.0

